

stored energy solutions for a demanding world

Narada

Model: **12HRL600**

HRL Series

The HRL range of VRLA batteries with 12+ years design life is perfectly suited to any application which requires a high rate current over a short period. In particular they are ideal for IDC and UPS systems thanks to their optimized performance and a patented post seal design. Meanwhile with excellent uniform battery performance, long design life wide usage temperature range, HRL series are suit for high ambient temperature.

Dimensions—mm [inch]

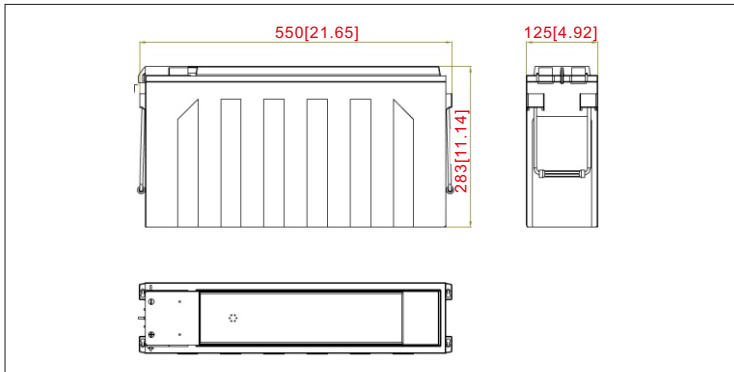

Specifications

Battery Model	12HRL600
Nominal Voltage	12V
Rated Capacity	600 W/cell(15 minute rate, 1.67 V/cell) and 150Ah(10 hr to 1.80V/cell) @25°C(77°F)
Typical Weight	51kg
Internal Resistance	Approx 3.29mΩ
Temperature Ranges	Operation (maximum): -40°C to 55°C(-40°F to 131°F)
	Operation (recommended): 15°C to 25°C(59°F to 77°F)
	Storage: -20°C to 40°C(-4°F to 104°F)
Float Voltage	2.27V/cell@25°C(77°F)
Recommended Maximum Charging Current Limit	37.5A
Equalize and Cycle Service	2.35V~2.40V@25°C(77°F)
Self Discharge	The residual capacity is above 94% after 90 days storage(25°C/77°F)
Terminal	M6 Female
Terminal Hardware Torque	8±1.0Nm
Container Material	ABS (V0 optional)

Discharge Data with Constant Power Units: Watts per cell (25°C, 77°F)

End voltage per cell	5min	10min	15min	20min	30min	40min	50min	1h	2h
1.60V	979.3	772.6	621.4	515.5	388.3	292.7	250.0	218.0	122.8
1.67V	920.0	736.0	600.0	503.0	384.3	292.1	249.0	217.0	122.0
1.70V	879.7	711.5	586.2	495.4	382.6	291.0	248.0	216.0	121.0
1.75V	797.7	667.7	562.2	482.1	378.9	290.0	246.0	215.0	120.0
1.80V	718.7	624.2	535.4	464.2	369.3	286.6	245.5	214.5	119.2
1.83V	675.1	592.2	510.8	444.7	355.6	277.0	237.9	208.2	116.5
1.85V	643.0	565.0	488.4	426.0	341.9	267.2	230.2	202.0	114.5

Discharge Data with Constant Current Units: Amperes (25°C, 77°F)

End voltage per cell	5min	15min	30min	1h	2h	3h	4h	6h	10h
1.60V	627.4	345.4	207.8	113.0	63.3	44.7	34.8	24.4	15.5
1.67V	563.4	335.3	205.9	112.0	63.0	44.4	34.6	24.2	15.4
1.70V	530.8	328.5	204.0	111.5	62.7	44.2	34.3	24.0	15.3
1.75V	476.0	313.4	198.9	110.0	62.2	43.9	34.1	23.9	15.2
1.80V	424.1	290.5	188.6	106.3	60.9	43.2	33.7	23.6	15.0
1.83V	392.8	270.7	178.7	102.7	59.8	42.8	33.5	23.3	14.7
1.85V	365.4	249.7	168.6	99.8	59.6	42.7	33.4	23.2	14.2

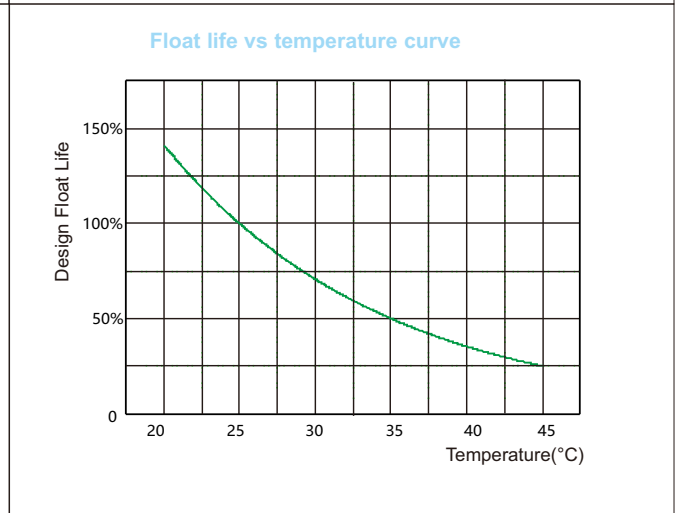
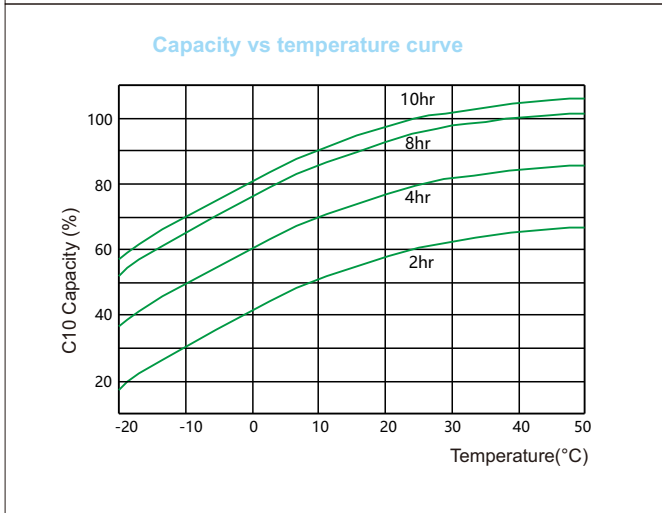
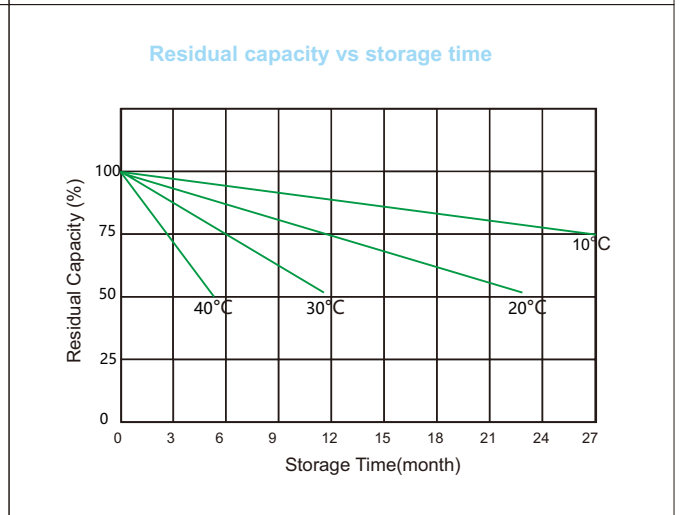
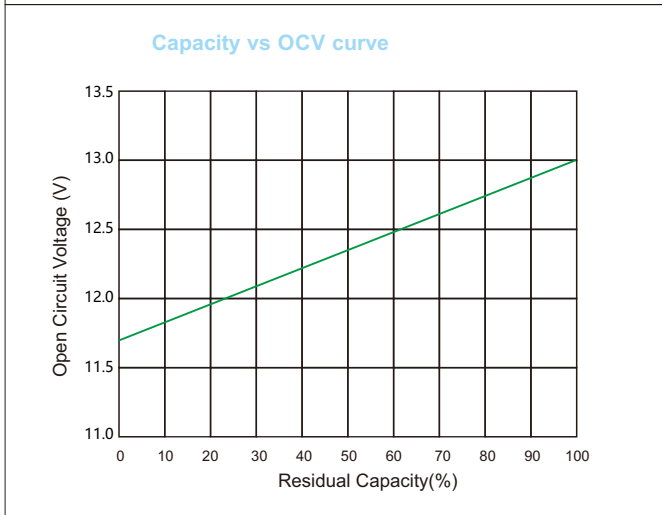
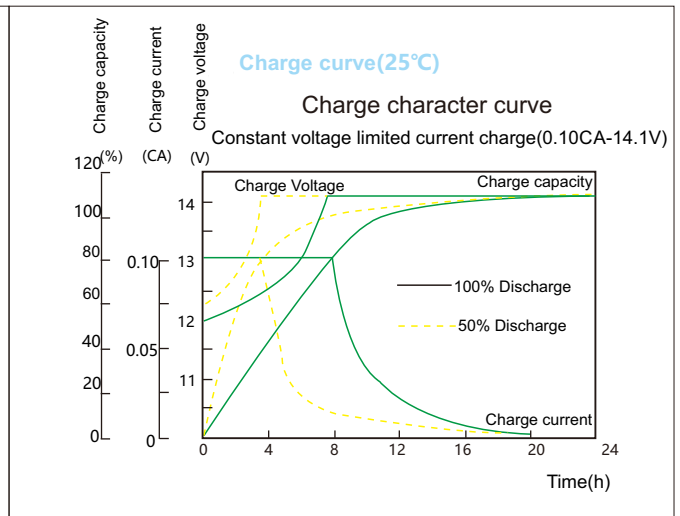
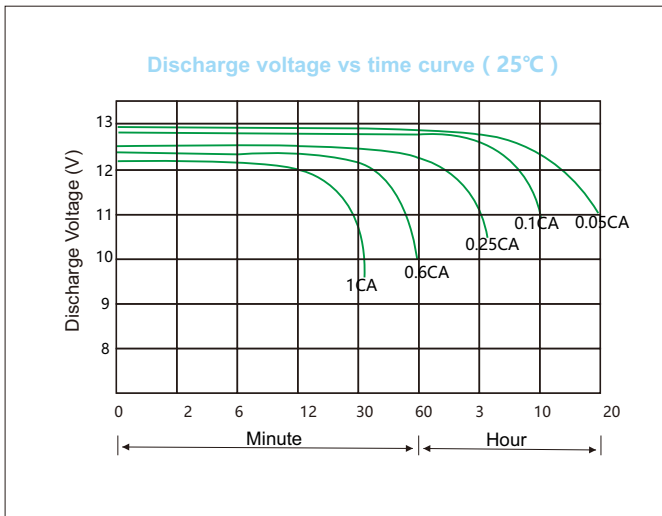

Zhejiang Narada power source Co., Ltd.
 Add: Building A, No.822 Wen'er West Road, Zhejiang, China
 Tel: (86 571)56975980 Fax:(86 571)56975955
 Email: intl@narada.biz Website: www.naradapower.com

